

efi MEZZERA DENIM LINE

Rope Dye, Loop Dye, Denim Flat Finishing



Indigo
dyeing and
finishing
ranges

Mezzera Worldwide

Mezzera, an Italian textile machinery manufacturer, has been in the textile business since 1934. They have designed and developed numerous wet and dry finishing treatments, cooperating with major international partners. Mezzera, known in the world of wet treatment because of its pre-treatment and after-printing or -dyeing lines, is the leading Italian textile provider that specialises in dyeing and finishing solutions.

Since 2009 Mezzera has been part of the Reggiani Group, which includes Reggiani Macchine, Jaeggli Meccanotessile, RPR and MTS. Today, Mezzera is the leader in the Italian market because of the continuous washing, bleaching, and mercerising plants for any kind of fabric. Mezzera has been part of EFT™ since 2015.



Indigo Dye

Loop, Slasher, or Rope?

When a new customer is introduced to the world of indigo, the first and most important question is this: What does the customer need, and why does he or she need it?

Why a rope dyeing range?

- **High production:** Dyed cotton in Kgs/h is around two to three times as much as other ranges
- **Lower sensibility:** Works with different types of cotton variations
- **Maximise production:** Suitable for reduced shade ranges for maximising denim production (no stops between dye lots)
- **Easier:** Operators find this technique easier to use
- **High fixation rate:** Wider and longer oxidation allows better brightness and colour fastnesses

Why a slasher dyeing range?

- **High flexibility:** Flexibility is higher for final products' yarn counts, chemicals, and processes
- **Smaller:** 20% more compact, and because it is all in one, it could preserve up to 35% of the total space
- **Cheaper:** Daily machinery and operating costs are up to 20% lower than a rope range
- **Higher efficiency:** Products are ready to be woven
- **More sustainable:** Up to 35% less chemicals and liquor compared with rope dyeing

Negative overviews

- **Labour costs:** At least half the labour involved in dyeing-rebeaming-sizing operations
- **Installation space:** Two to three times the range of slasher or loop processes
- **Shirting or fine counts:** Dyeing range between Ne 6/1 - Ne 30/1 max
- **Flexibility:** Twice as much flexibility in terms of liquor and cotton loads
- **Unsustainability:** High consumption of chemical water

Negative overviews

- **Impractical:** Experience on this range and precautions are required
- **Lower oxidation:** Skying are lower than a rope dyeing range
- **Cotton waste:** In cases of stops and during dye load changes, machine has to be stopped, resulting in loss of cotton load inside
- **Centre-selvedge:** If not well settled, especially on thick counts, centre-selvedge shading can occur

Loop Technology

Loop technology has been used since 1980s because of lower space requirements and more flexible solutions for indigo denim factories.

Mainly made with one or two indigo boxes in the early years, the market grew, and a product that started as a mono-shade product became fashionable for everyday use in every season. By widening the colours, intensities, and shades, the new Looptex range by Mezzera changed the world of machine manufacturing by combining advantages of old loop machines with the latest chemical and mechanical technology, resulting in darker casts, deeper indigo penetration, and improved fastness that is identical to rope and slasher ranges but with the advantages and flexibility of Mezzera's Looptex technology. We have adapted this for today's changing market requests.

Looptex is a perfect melting pot of history, technology, and experience

Looptex Technology by Mezzera is a perfect example of how old technology can be modified and renewed, resulting in a new product that mixes the advantages of the latest rope and slasher technologies to satisfy any customer's requests.

Why a Looptex dyeing range?

- **Higher flexibility:** Flexibility is higher for all processes because of the smaller machine size and the sealed nitrogen reactors (patented); we offer a 360° product that is suitable and stable for indigo dyeing between 0.3% and 6% intensity and sulphur dyeing for pastels to the deepest black
- **Operating costs:** Up to 30% less because of the reduction of the indigo liquor bath and the machine's size, which is up to 20% smaller than a standard machine
- **Chemical costs:** Up to a 40% reduction in hydrosulphite thanks to the sealed nitrogen reactors
- **High fixation rate:** Because yarns pass into the oxidation loop many times, the fixing rate, intensity, and fastness are excellent
- **Lower cotton lost:** In case of machine stops the lost load is 25% lower than a standard slasher
- **Sustainability:** Reducing machine boxes but not the final speed, water and chemical consumption are lower than other ranges
- **Slasher-loop:** Based on customer requests, it is possible to customise the Looptex machine to use as a loop or slasher process as well
- **Higher productivity:** Faster than every other range up to 38 m/min

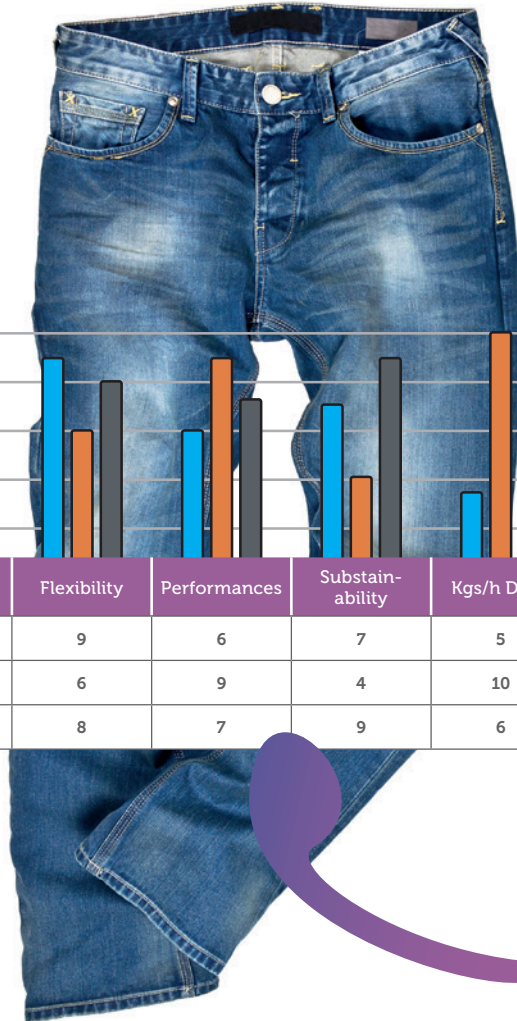

Ranges Comparison

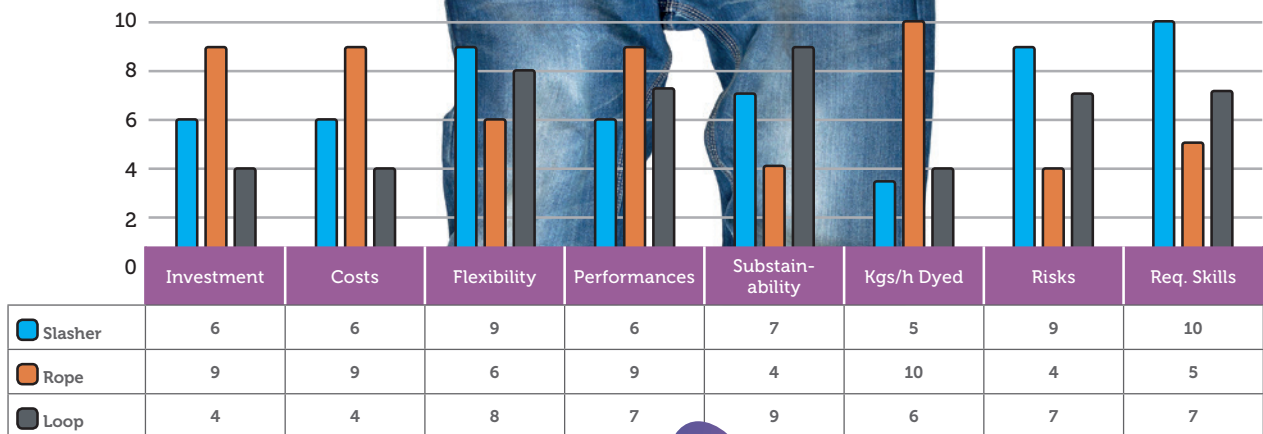

Rope Dye

Features

- Working speeds from 30 m/min up to 40 m/min
- Featuring between 24 -36 ropes, fully automatic coiler controlled by Siemens PLC
- Upper guide rolls with fluted profiles
- Continuous fresh-dye liquor bath dosing system based on ml/kg
- Independent magnetic flowmeters installed on each dye box for a balanced indigo liquor supply

Standard rope dye range (eight boxes)

The standard rope dye range by Mezzera has been developed to give you the best solution and flexibility for your initial investment.

Supported suitability and characteristics

- Double steamer (bottoming-topping/sulphur colour denim)
- Medium-high indigo intensities achievable (4-5%)
- Sulphur bottomed indigo casts all colours
- Sulphur topped indigo casts all colours (last two indigo boxes with independent circuit)
- Sulphur dye all colours (last two indigo boxes + steamer)

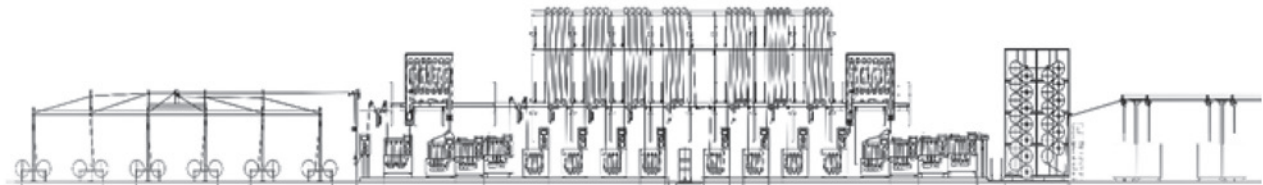

Standard 4.5% indigo dyeing machine set-up (report by Mezzera)

Performer rope dye range (10 boxes: eight indigo + two nitrogen reactors)

The performer rope dye range by Mezzera was developed to give you the best solution for dye performance thanks to the twin box equipped with the sealed nitrogen reactors, penetration, fastness, washing resistance, and intensity in indigo and sulphur.

Supported suitability and characteristics

- Ultra-high indigo intensities achievable (5.5-6.5%)
- Sulphur bottomed indigo casts all colours
- Sulphur dye all colours (last two indigo boxes in nitrogen environment)
- Darker and well fixed sulphur blacks
- Sustainable, more than 40% hydrosulphite could be reduced during production
- Speed 35 m/min

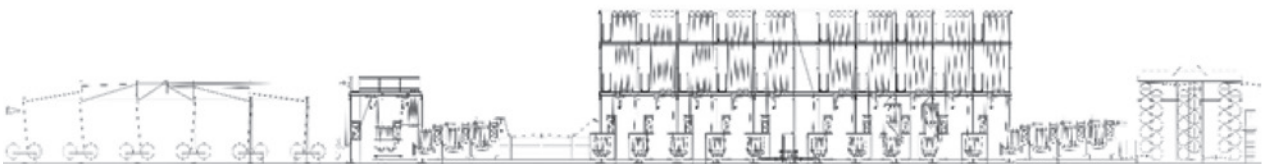

The sealed nitrogen reactors keep indigo in LEUCO-FORM (green). During its penetration, giving the possibility to be uniformed diffused into the fiber, reducing also the environmental impact.

N₂ Mezzera sustainable process 6N₂ sealed reactors

Mezzera is always thinking about our planet and how we can be greener. In 2003, we developed an indigo dyeing process in which the reducing agent (hydrosulphite) is reduced by 60%, decreasing the release of polluting agents and sulphur content into wastewater and fibers. This process allows us to produce a low content of sulphates/ sulphides in indigo dyeing, drastically reducing the environmental impact and the costs.



Reactor
Reactor O₂ content <1%
Double dip 1.9 m + 0.5 m
Dwelling 18 m

Nitrogen dyed vs. std. dyeing

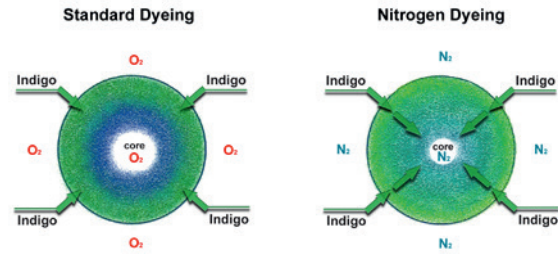

2.7% Indigo
results after 25 min rinse

- **Sulphate and sulphides:** Drastic reduction on yarns and waste water
- **Hydro reduction:** Minimum of 30% reduction of hydro and caustic used during the dyeing, up to 60% in case of dyeing only with reactors
- **Fastness improvement:** Minimum 1 point on dry and ½ on wet
- **Sulphur no steamer:** No need to use a steamer for sulphur dyeing, using the nitrogen sealed reactors for higher penetration

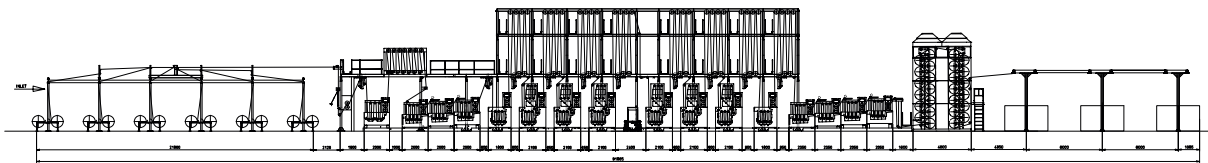

Process: Scouring at 60°C; washing boxes A-B-C; boxes 1-2, water; nitrogen boxes 6-9, indigo; box 10, water. It is possible to skip boxes 1-5 to preserve water. Dyeing indigo using just the nitrogen boxes would reduce hydrosulphite consume up to 60%.

Loop-slasher dye

Features

- Working speeds from 30 m/min - 40 m/min
- Continous fresh dye liquor bath dosing system based on ml/Kg
- 50% less dyeing bath liquor than other ranges
- Reduced initial investment
- Smaller size up to 35% less than other ranges
- High sustainability
- Highest flexibility in denim world without renouncing to any denim trend characteristic
- Independent indigo boxes for higher shade flexibility

Looptex goes back in the past to be one step closer to the future

We went back to the old Loop technology, studying it, in order to re-adapt and renew it. Motivated by market requests and needs, assembling it to achieve the best parts and performances of all indigo dyeing ranges.



Looptex 2N₂

Supported suitability and characteristics

- Steamer (bottoming-topping/sulphur colour denim)
- High indigo intensities achievable (5-6%)
- Sulphur-bottomed indigo casts for all colours
- Sulphur-topped indigo casts for all colours (independent circuit)
- Sulphur dye for all colours (wet-on-dry or wet-on-wet into N₂ reactor)
- Flexibility (from two indigo boxes to nine with three loops)
- High oxidation and fixation rate

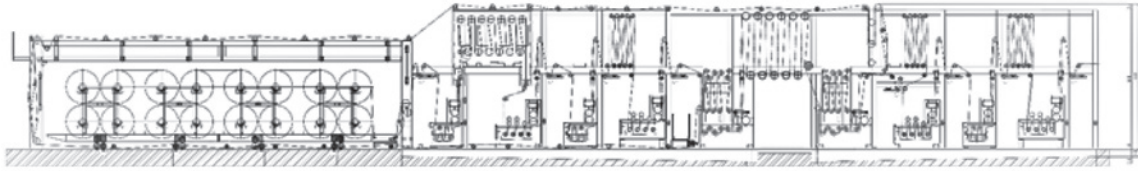

Process: Pre-wetting box (dry-on-wet indigo), wash, indigo, skying, four passes in indigo boxes, N₂, wash, one indigo box independent of main circulation – neutralizing wash, pH 5.5. Total dips with three loops with different indigo concentration and circulation: nine indigo dips

Sulphur dyeing machine setting for dark colour denim (report by Mezzera)

The high penetration of the N₂ atmosphere makes it possible to use Looptex as a single pass (slasher mode) without using the steamer.

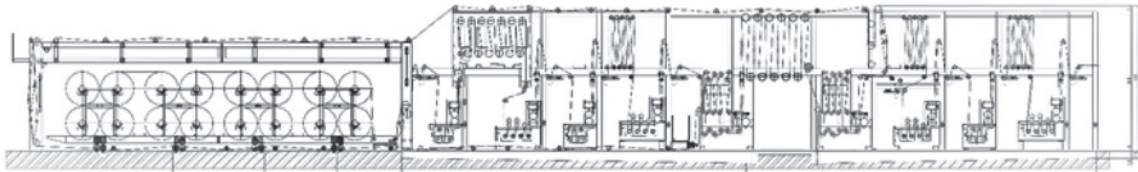

Process: Pre-wetting box (scouring), three washes, two sulphur box passages in N₂, two washes, one oxidising box (H₂O₂ + pH 4.5). Total dips with one loop (slasher mode): two sulphur dips.

Top performer Looptex (Loop/Slasher)

With the top performance of the Looptex, equipped with two new-generation nitrogen reactors and four indigo-topping boxes, more flexibility is possible. It can be used as a slasher, achieving already dark casts (4.5-5%), or it can process yarns with loop technology, achieving the darkest cast possible with sheet dyeing machinery (6-6.5%), passing into reactors six times, topped with four extra indigo boxes.

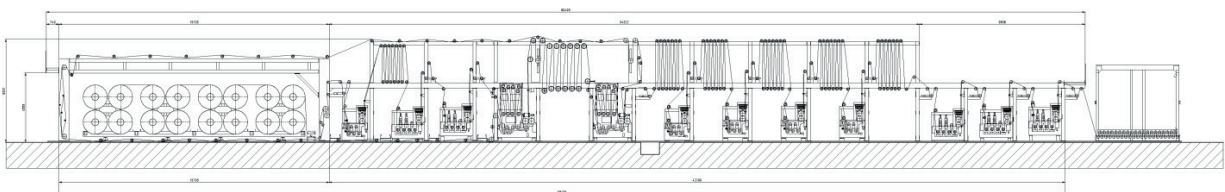

Indicone Mezzera vat dyed yarns for knits

The indigo world is in continuous revolution, every year globally, more than 2 billion garments are produced. Customers are always requesting new products to satisfy their needs. Last year, the world of denim moved to a more comfortable and technical solution. As a result, we developed Indicone, a small vat dye range with the capability to produce either indigo- or sulphur-dyed yarns, with the typical look of ring-effect denim ready to be unwound on cones and used for circular or plain knitting, structured woven, and shirting.

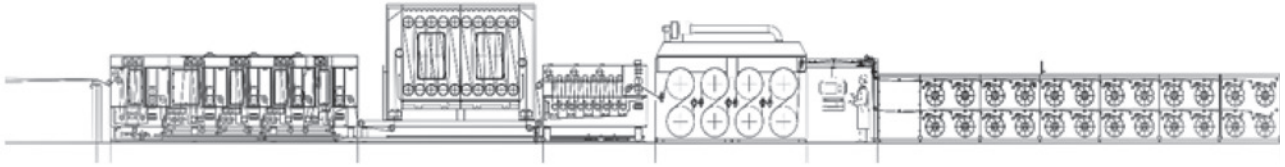

Process: Pre-wetting box (scouring low concentration), three indigo dips in nitrogen atmosphere, one wash, one oxidation steamer unit, one wash fixing unit, cylinder drying unit – 6 or 12 rebeaming unit (40 ends each).

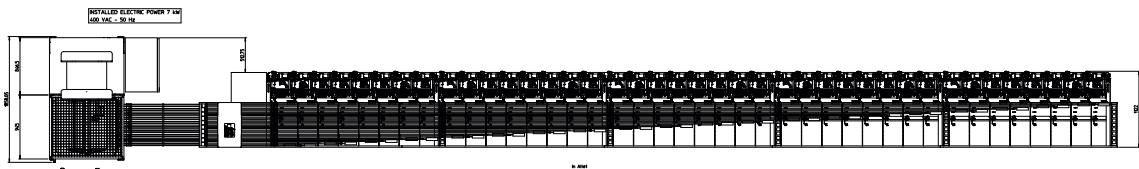
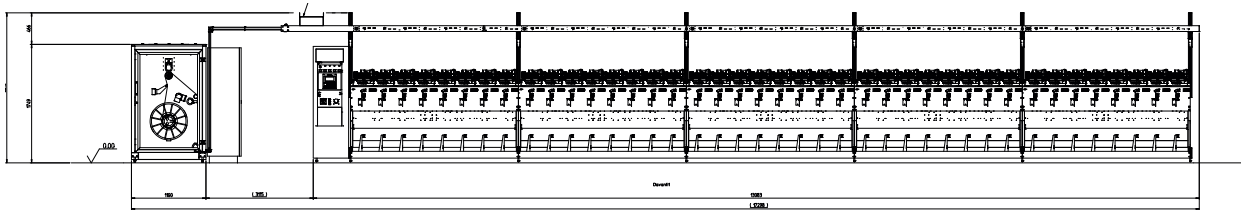



Caustifying – mercerizing denim units

Before deciding on a denim finishing unit, it is important to understand the differences between mercerization and caustification ranges.

The graph, below on the left, shows the increase in the max wetting power on cotton, between 23°Be' - 27°Be'. The other graph shows that brightness and dimensional stability have opposite behaviours, so the typical working temperature for a previously dyed denim is between 23°Be' - 27°Be'. From the other graph we see that brightness and dimensional stability have completely opposite behaviours—usually the working temperature for an already-yarn dyed denim is between 25°C - 35°C.

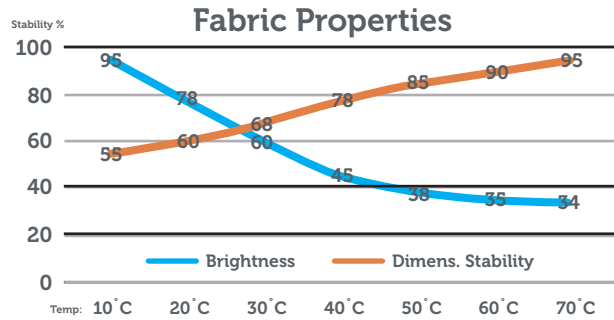
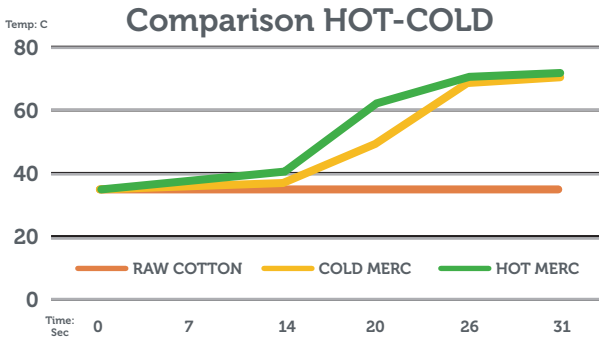

Activa washing boxes

The Activa washing box is suitable for all applications because it uses the mass exchange by dilution between fabric and liquor as the main washing mechanism. Activa boxes force the flow to pass through a series of labyrinth baffles.

All Activa washing boxes feature lower rolls that are individually driven by motor-gear groups that run the inverters and load cells on the bottom guide rollers, which read the fabric tension value and synchronise the tension, avoiding creases.

Activa E620

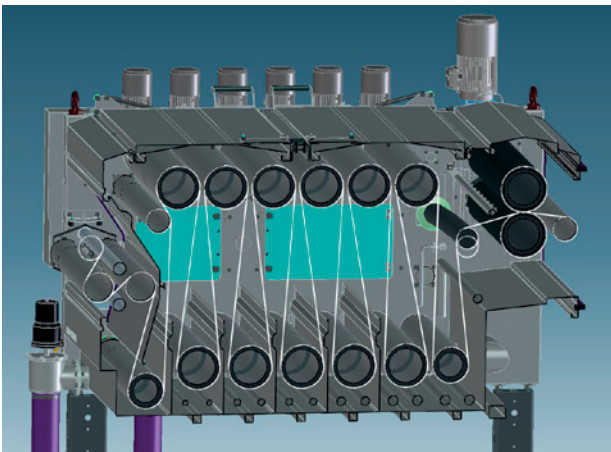

Activa D740

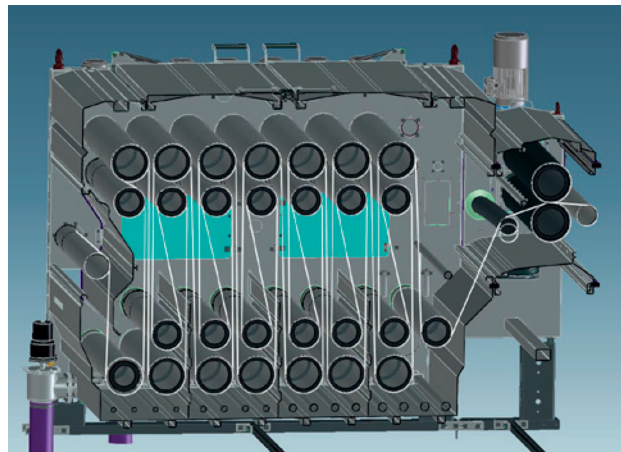

Activa-S double and Activa double thread come with two separate compartments, a double water inlet, and independent hermeregulation systems for more wash power and fabric inlet needs.

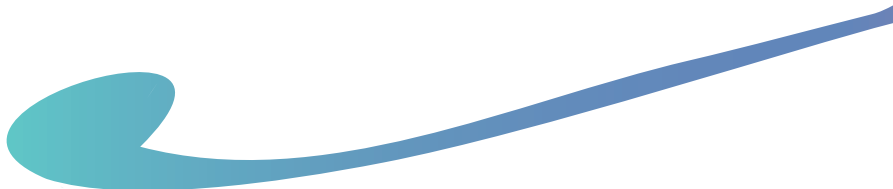

Denim caustifying unit and skew regulator (rigid-low elastane content)

Supported suitability and characteristics

- Working speed 35 m/min
- High extracting capability with boxes
- Caustic self-cleaner filter
- Optional final softening agent box
- Water consumption between 12-20 l/kg
- Working width between 1800 mm - 2600 mm
- Lower steam consumption thanks to the high squeezing final foulard 10 tons
- Skew movement unit and automatic reading unit

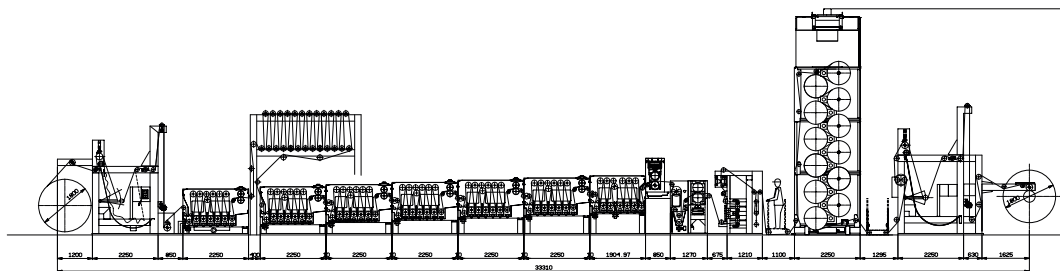

Process: NaOH padding box, best at 25-30°Be' at 25-30°C max; 30m caustic reaction development; five wash boxes, 50°C-70°C; one neutralising pH 4.5 washing unit; one high-pressure foulard, 10 tons; skew movement unit regulator, drying unit, skew movement reader.

Denim mercerizing unit (rigid + high elastane content)

Supported suitability and characteristics

- Working speed 40-50 m/min
- High extracting capability with Activa boxes
- Caustic self-cleaning filter
- Padding – reaction unit roll to roll (avoiding self-twisting)
- Water consumption between 12-20 l/kg
- Working width between 1800 mm - 2600 mm
- Dyeing length 30 m
- Stabilisation length 15 m

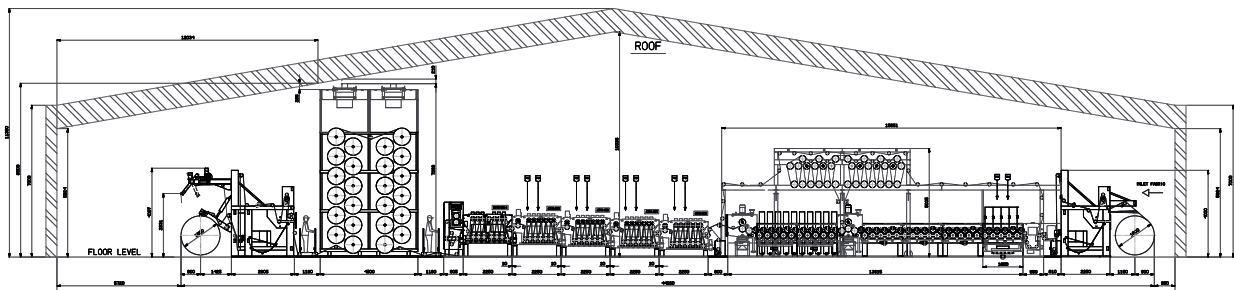

Denim desizing and mercerizing unit (rigid + high elastane content)

Supported suitability and characteristics

- Working speed 50 m/min
- Singeing front/back
- High extracting capability with Activa boxes and Activa double thread
- Caustic self-cleaning filter
- Padding-reaction unit roll to roll (avoiding self-twisting)
- Water consumption between 12-20 l/kg
- Working width between 1800 mm - 2600 mm
- Steamer 80m fabric content
- Desizing padding box
- Caustifying wet-on-wet

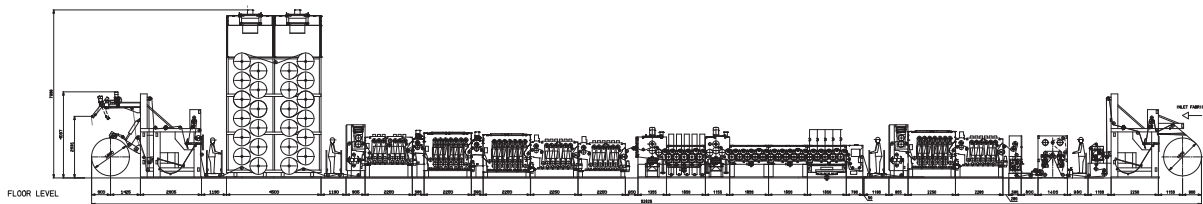

EFI fuels success.

We develop breakthrough technologies for the manufacturing of signage, packaging, textiles, ceramic tiles, and personalised documents, with a wide range of printers, inks, digital front ends, and a comprehensive business and production workflow suite that transforms and streamlines the entire production process, increasing your competitiveness and boosting productivity.

Visit www.efi.com or call +39 035 3844511 for more information.



Nothing herein should be construed as a warranty in addition to the express warranty statement provided with EFI products and services.

The APPS logo, AutoCal, Auto-Count, Balance, BESTColor, BioVu, BioWare, ColorPASS, Colorproof, ColorWise, Command WorkStation, CopyNet, Cretachrom, Cretaprint, the Cretaprint logo, Cretaprinter, Cretaroller, Digital StoreFront, DocBuilder, DocBuilder Pro, DockNet, DocStream, DSfdesign Studio, Dynamic Wedge, EDOX, EFI, the EFI logo, Electronics For Imaging, Entrac, EPCount, EPPPhoto, EPRegister, EPStatus, Estimate, ExpressPay, FabriVU, Fast-4, Fiery, the Fiery logo, Fiery Driven, the Fiery Driven logo, Fiery JobFlow, Fiery JobMaster, Fiery Link, Fiery Navigator, Fiery Prints, the Fiery Prints logo, Fiery Spark, FreeForm, Hagen, Inktenity, Inkware, LapNet, Logic, Metrix, MicroPress, MiniNet, Monarch, OneFlow, Pace, Pecas, Pecas Vision, PhotoXposure, PressVu, Printcafe, PrinterSite, PrintFlow, PrintMe, the PrintMe logo, PrintSmith, PrintSmith Site, PrintStream, Print to Win, Prograph, PSI, PSI Flexo, Radius, Remoteproof, RIPchips, RIP-While-Print, Screenproof, SendMe, Sincolor, Splash, Spot-On, TrackNet, UltraPress, UltraTex, UltraVu, UV Series 50, VisualCal, VUTEK, the VUTEK logo, and WebTools are trademarks of Electronics For Imaging, Inc. and/or its wholly owned subsidiaries in the U.S. and/or certain other countries.

All other terms and product names may be trademarks or registered trademarks of their respective owners, and are hereby acknowledged.