

The image features a close-up of a person's arm and a piece of fabric with a repeating daisy pattern. The fabric is light green with white daisies that have red and yellow centers. The background is a lush green lawn. In the upper right, the 'efi' logo is displayed in a white, italicized font. To its right, the text 'Reggiani UNICA' and 'Rotary Printer' is written in a clean, white, sans-serif font, separated from the logo by a thin vertical line.

efi

Reggiani UNICA

Rotary Printer

Technology and
tradition for the
best quality

UNICA. Analogical excellence.

EFI™ Reggiani's success is largely due to UNICA, the rotary screen printing machine. More and more customers worldwide are printing woven and knitted fabrics, wide and narrow width, for household and fashion — with great satisfaction and profitability.

The new printing units highlight the typical features and advantages that, for more than 75 years, have made EFI Reggiani the manufacturer of reference for top-quality printing machines:

- Closed bearing printing heads
- Multi-repeat printing heads (from 640 to 1018 mm, no tools needed)
- Totally sealed and lubricated printing heads (no maintenance required)
- Stepless adjustment of printing height according to fabric thickness
- Stepless adjustment of printing width (any screen cutting length accepted)
- Individual screen drive with one or two brushless servomotors in closed loop
- Uniflux linear magnetic system
- Easy and simple machine operation, with touch screen interfaces
- High reliability-efficiency electronics.

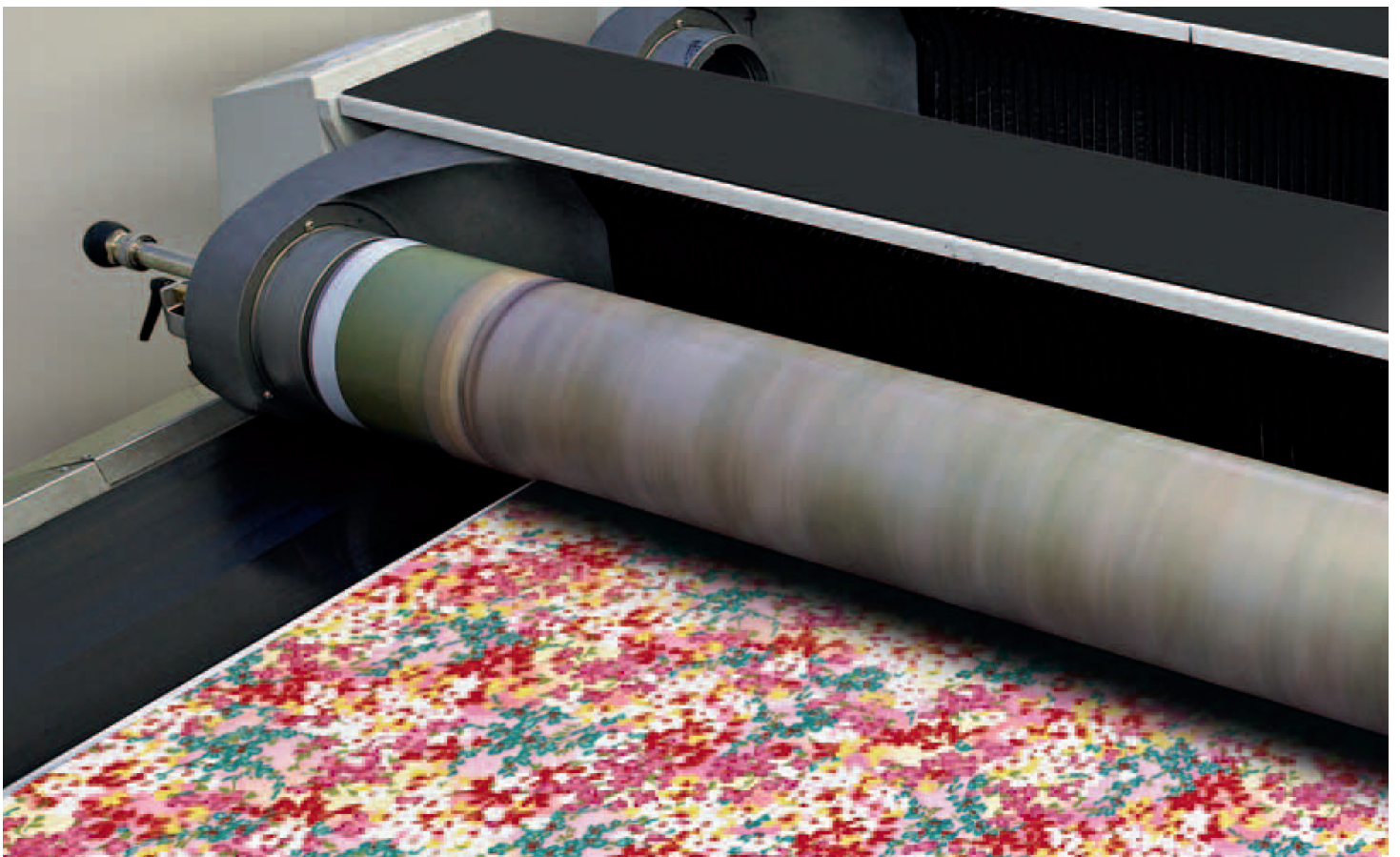



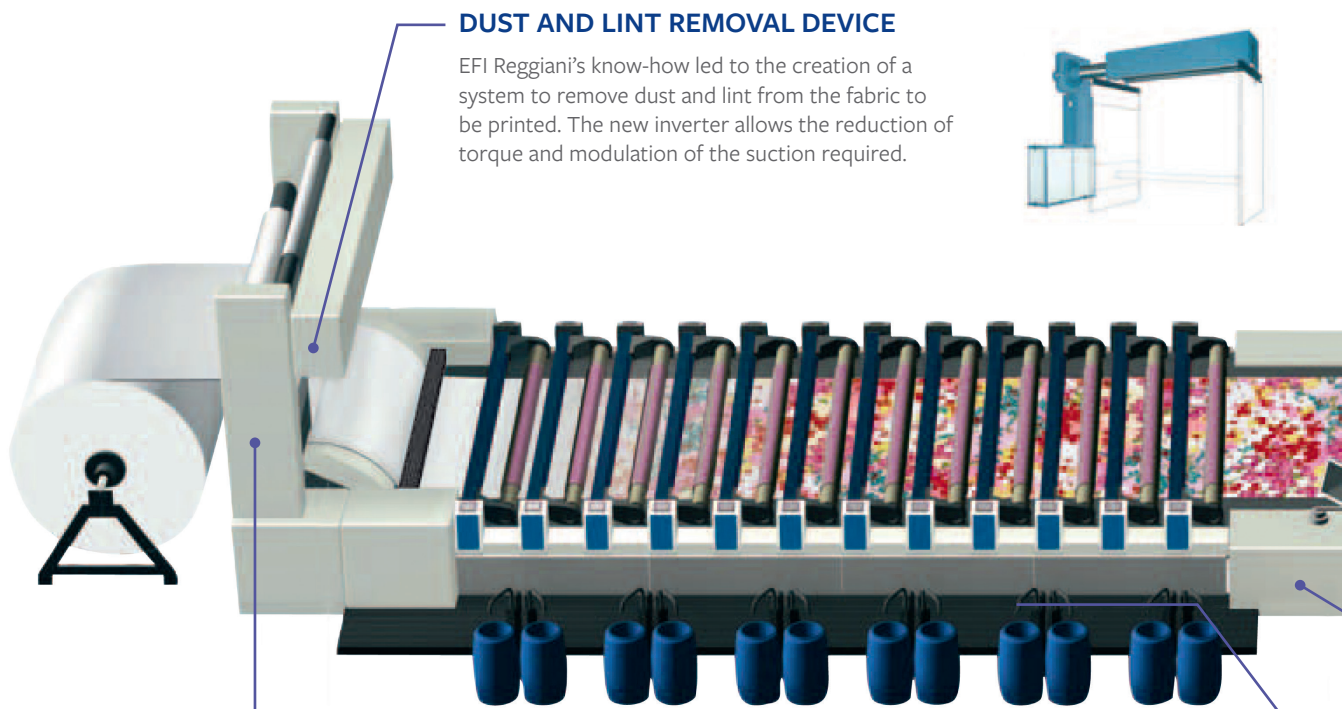

DUST AND LINT REMOVAL DEVICE

EFI Reggiani's know-how led to the creation of a system to remove dust and lint from the fabric to be printed. The new inverter allows the reduction of torque and modulation of the suction required.

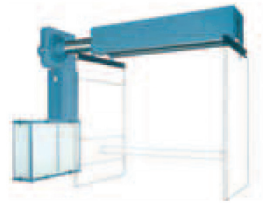

THE NEW PNEUMATIC GLUE APPLICATION

Allows for perfect and continuous adjustment of the thickness of the glue on the fabric, reducing maintenance.

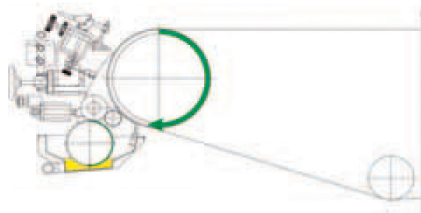

RAPID PUMP WASHING (OPTIONAL)

This system was introduced on EFI Reggiani machines to dramatically reduce the waste of time and water, allowing the rapid washing of the colour-feeding circuit (ducts, suction, delivery, colour pump) by means of established sequences of pressurised water ejections. The standard time execution is 30 seconds; the maximum water consumption is 30 litres/colour.

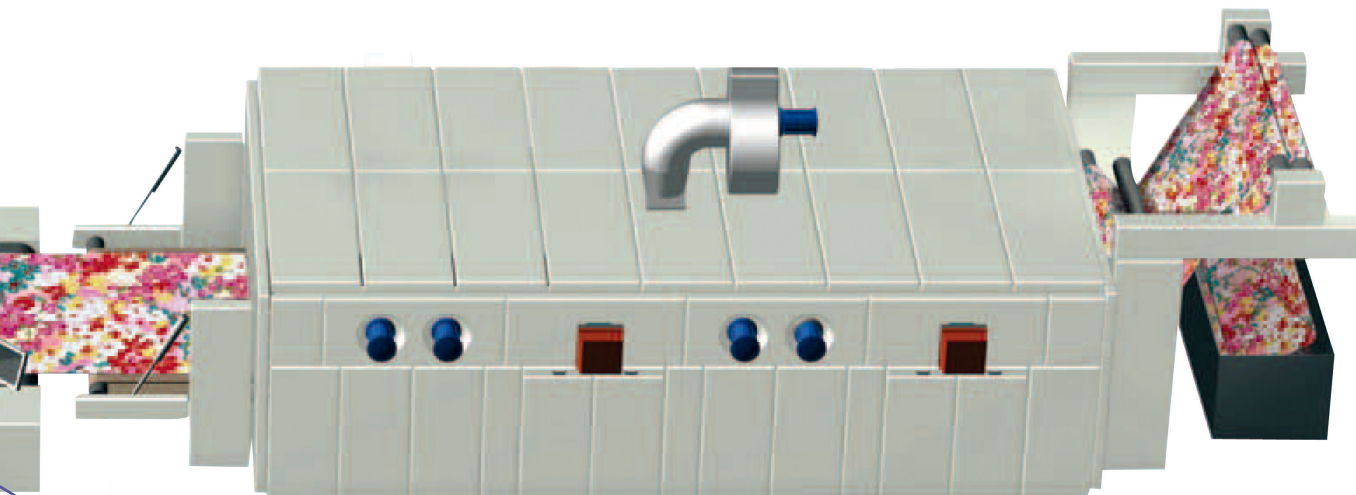

THE NEW BLANKET WASHING SYSTEM

Considerably reduces water consumption. Two brushes, one for each tank, work with variable speed to optimise blanket cleaning. Four rubber squeegees (the last one adjustable as well) clean and dry the blanket perfectly. The two brushes are equipped with inverters that allow the reduction of torque and the adjustment of the brushes' rotation speeds according to the printing speed.

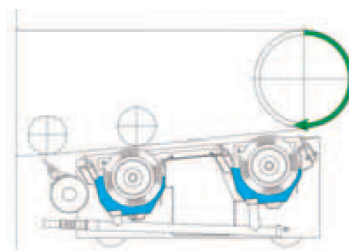

PUMPS

Pneumatic stainless steel pumps with different deliveries. The high quality components allow the use of colour pastes with different viscosities, always assuring perfect printing evenness.

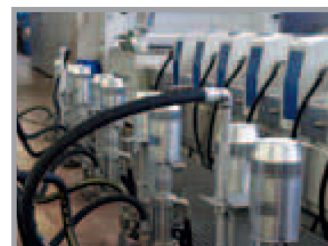

Closed-bearing print heads

- High precision and accuracy
- Self-aligning screen holders
- Evenness in screen tension
- Perfect driving of the screen
- No risk of damaging the screens, no mechanical wearing
- Totally sealed and lubricated print heads (no maintenance required)
- Easy screen installation (with one operator only)
- Optimum control/access to the printing, even with big repeats, thanks to the large distance between the print heads

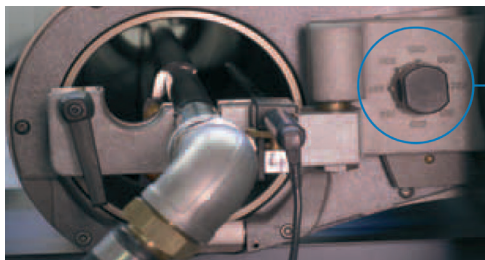

- 640
- 668
- 688
- 725
- 801
- 819
- 914
- 1018

Uniflux linear magnetic system

- Perfect evenness and uniformity, even with wide width fabrics
- No centre-right, centre-left effect
- High flexibility
- Digital printing pressure stepless adjustment, from ultra-low to very high pressure
- High efficiency and very low energy consumption
- No pole-to-pole overpressure (typical in multi-beam magnet systems)

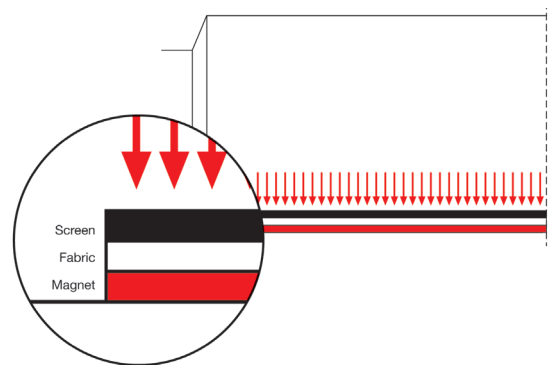

Multi-repeat print heads

Totally pneumatic and electronically controlled between 640 and 1018 mm, and no tools are needed to change the repeat. The operator sets the repeat value on the main touch screen, and all the print heads raise up so the screens can be easily installed on the machine without any extra mechanical parts to save time.

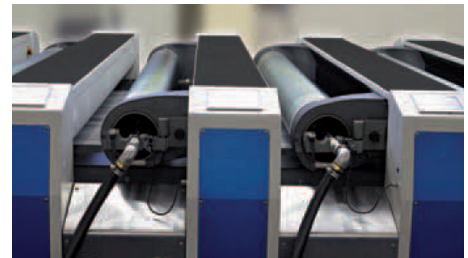

Individual screen drive

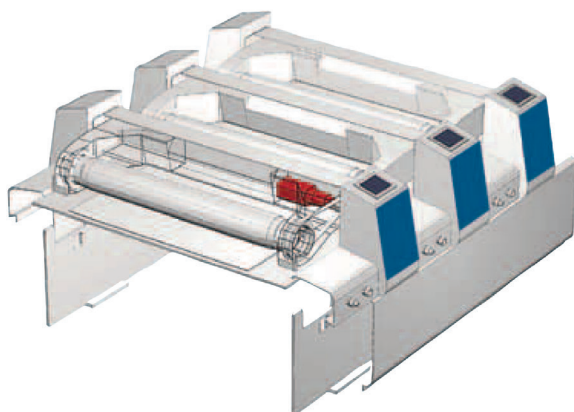

With one brushless servomotor

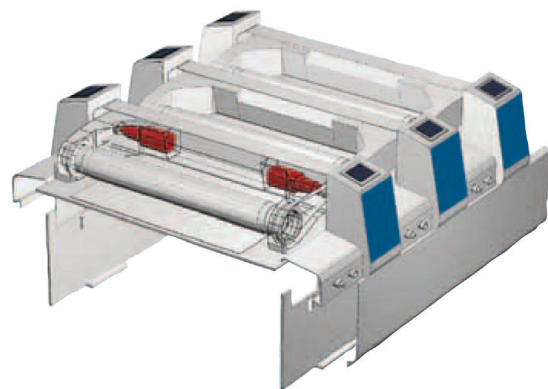

With two brushless servomotors

Easy and friendly machine operations, high efficiency and low consumption

All the electronic components are the most updated and highest performing available on the market: the standard of Siemens (PLC, motion controls, inverters, control panels, and touch screens).

The interfaces are simple to understand and easy to use:

- One touch screen at the front of the machine
- One touch screen on each printing unit (optionally available on both sides)
- One main control board with a 15" TFT touch screen
- One touch screen at the exit of the dryer

The printing and design parameters can be easily adjusted, saved, and automatically reproduced. High reliability and very low energy consumption are the results of EFI's continuous efforts and investments in R & D.

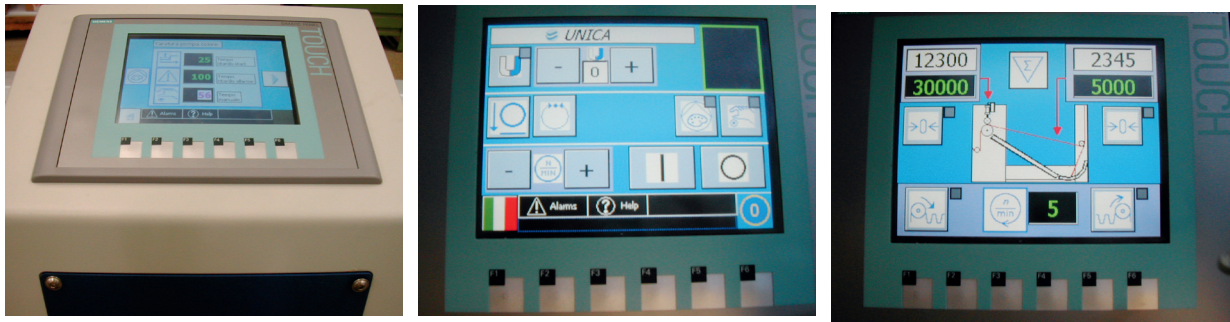

Energy consumption is becoming more and more important in an industrial budget.

EFI Reggiani, which has always been concerned about environmental issues, has equipped its UNICA rotary printing machines with inverters on the dust and lint removal device, on the blanket washing, on the dryer fans, and on the dryer exhaustion to guarantee a 25% savings on energy consumption.

Blade squeegee 180 cm, repeat 640

Squeegee blade isoform print height 1800, repeat 640. Each situation requires a diverse setup; with available adjustments of the printing squeegee system/colour/cylinder the squeegee isoform can be used for any type of printing on any article. The operations of introduction/extraction is facilitated by the swivel releasing completely in the introduction section.

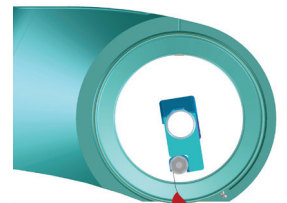

Washing-on-line system (optional)

The washing-on-line (WOL) system patented by EFI Reggiani (patent N.1.271.128) is more and more appreciated by customers worldwide.

With no operator required, in 10-12 minutes, it is possible to wash and dry all the screens, pumps, colour pipes, and the blanket on the machine.

The length and amount of washing and drying cycles can be determined by the operator (and then saved and automatically reproduced).

After the washing/drying cycles, the machine is ready to re-start printing without any extra time to register the screens.

Conceived mainly for the colourways, the WOL washes so fast and well that it is typically used for printing new designs, too.

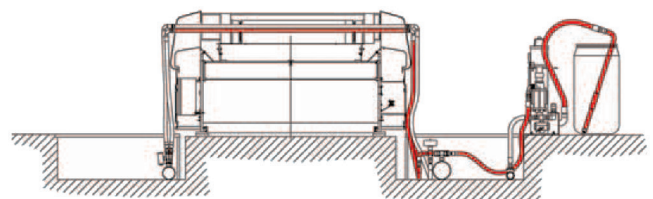

During printing

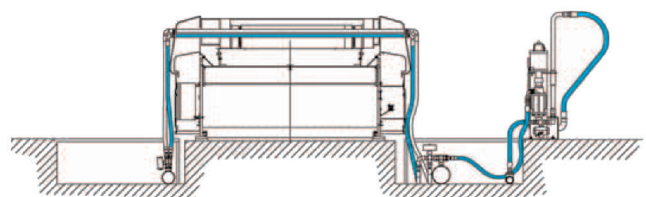

During washing

TECHNICAL DATA

Models	180, 240, 320 cm
Number of colours	up to 24
Speed	up to 90 m/minute
Print heads	closed bearing, self-aligning, lubricated
Multi-repeat print heads	from 640 to 1018 mm, stepless adjustment, electronically controlled
Screen drive	with one or two brushless motors
Printing width	stepless adjustment
Squeegee system	with Uniflux linear magnetic system
Operating and colour side	right or left
Gluing system	water soluble glue as well as thermoplast
Blanket washing system	two variable speed brushes, four rubber squeegees (the last one adjustable)
Interfaces	touch screens on each printing unit, touch screens at the entry/exit of the machine, one control board with a 15" TFT touch screen; all with colours
Electrical cabinet	conditioned
Tele assistance	built-in modem for troubleshooting and telediagnosis

EFI reserves the right to modify, at any moment and without prior notice, the data and technical specifications published herein.

Let's be brilliant. Together.

We understand you want breakthrough technologies to lead you through your digital journey. That's why we're passionate about driving your business growth with a scalable portfolio of products, solutions, services, support, and world-class partnerships for the manufacturing of signage, packaging, textiles, ceramic tiles, and building materials with a wide range of printers and inks. Our unwavering commitment is to increase your profits, cut costs, improve productivity, and optimise efficiency — job after job, year after year. We're obsessed with your success. And we definitely believe we have the right people, technology and experience to help your business achieve its goals. Visit www.efi.com/reggiani or call +39 035 3844511 for more information.



Nothing herein should be construed as a warranty in addition to the express warranty statement provided with EFI products and services.

AutoCal, Best Eye, ColorGuard, ColorPASS, ColorRight, ColorWise, Command WorkStation, Cretachrom, Cretaprint, the Cretaprint logo, Cretaprinter, Cretaroller, Divisional Graphics, Distancing Graphics, DocBuilder, Dynamic Wedge, EDOX, EFI, the EFI logo, Electronics For Imaging, FabriVu, Fast-4, FASTRIP, FASTDRIVE, Fiery, the Fiery logo, Fiery Compose, Fiery Driven, the Fiery Driven logo, Fiery Edge, Fiery Essential, Fiery HyperRIP, Fiery Impose, Fiery Impress, Fiery ImageViewer, Fiery Intensify, Fiery JobExpert, Fiery JobFlow, Fiery JobMaster, Fiery Navigator, Fiery Prep-it, Fiery Prints, the Fiery Prints logo, Fiery TrueBrand, FreeForm, InkIntensity, Inkware, IQ, MicroPress, OneFlow, PressVu, PrintMe, the PrintMe logo, Prograph, ProGraphics, RIPChips, RIP-While-Print, SafeGuard Graphics, Spot-On, Spot Pro, UltraDrop, UltraPress, UltraTex, UltraVu, UV Series 50, VUTEK, the VUTEK logo, and WebTools are trademarks or registered trademarks of Electronics For Imaging, Inc. and/or its wholly owned subsidiaries in the U.S. and/or certain other countries.

All other terms and product names may be trademarks or registered trademarks of their respective owners and are hereby acknowledged.

© 2023 ELECTRONICS FOR IMAGING, INC. ALL RIGHTS RESERVED. | WWW.EFI.COM

AC_82_05_23_UK