

The image features a close-up of a person's arm on the left side, resting on a vibrant green lawn. A piece of fabric with a repeating pattern of white daisies is spread out on the grass. Each daisy has a yellow center, and some have a red center. The fabric is slightly wrinkled, showing its texture. In the upper right corner, there is a logo and text for 'efi' and 'Reggiani UNICA Rotary Printer'.

**efi**

**Reggiani UNICA**  
Rotary Printer

Technology and  
tradition for the  
best quality



# UNICA. Analogical excellence.

EFI™ Reggiani's success is largely due to UNICA, the rotary screen printing machine. More and more customers worldwide are printing woven and knitted fabrics, wide and narrow width, for household and fashion — with great satisfaction and profitability.

The new printing units highlight the typical features and advantages that, for more than 75 years, have made EFI Reggiani the manufacturer of reference for top-quality printing machines:

- Closed bearing printing heads
- Multi-repeat printing heads (from 25 in/640 mm to 40 in/1018 mm, no tools needed)
- Totally sealed and lubricated printing heads (no maintenance required)
- Stepless adjustment of printing height according to fabric thickness
- Stepless adjustment of printing width (any screen cutting length accepted)
- Individual screen drive with one or two brushless servomotors in closed loop
- Uniflux linear magnetic system
- Easy and simple machine operation, with touch screen interfaces
- High reliability-efficiency electronics.

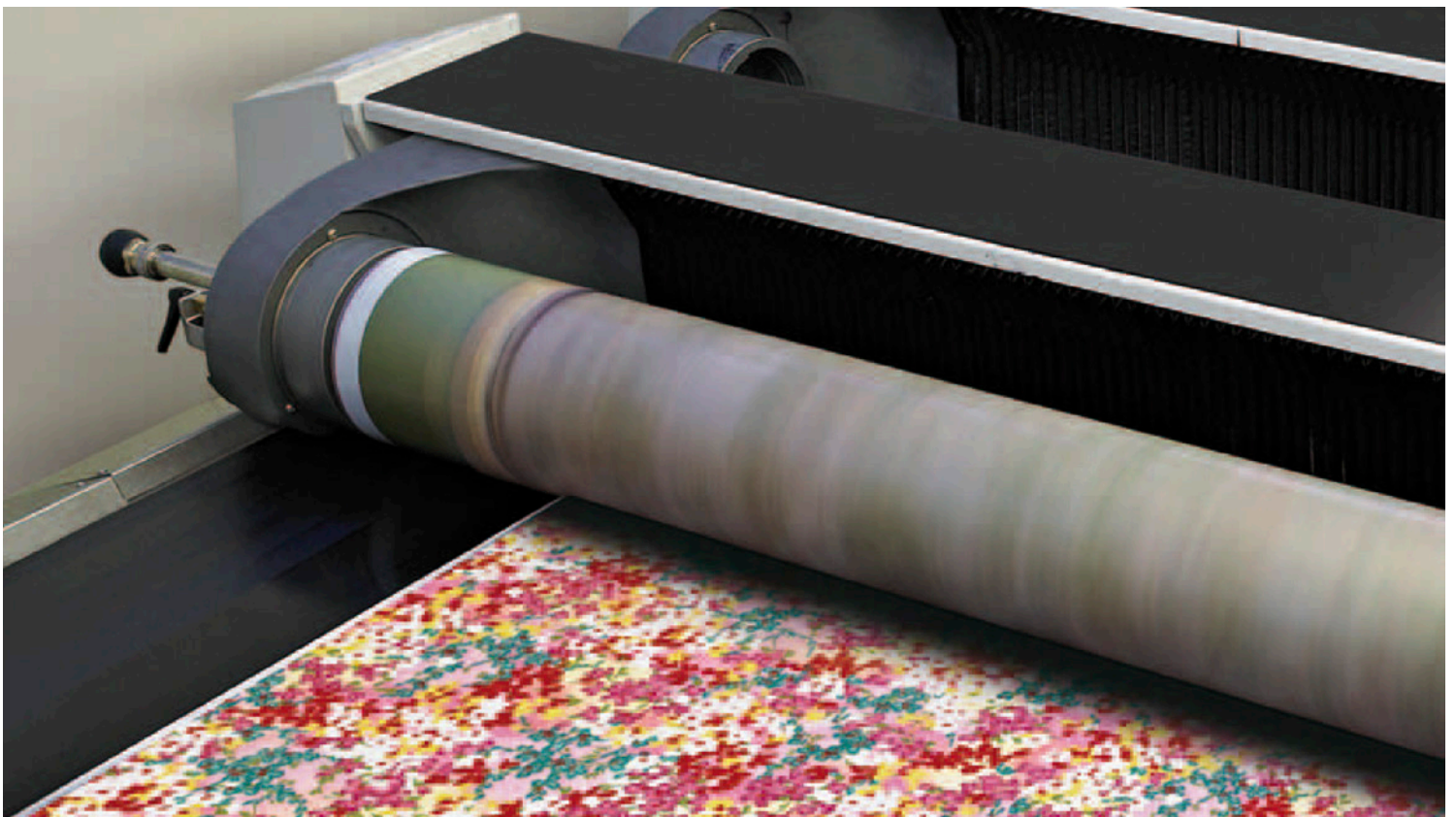







### DUST AND LINT REMOVAL DEVICE

EFI Reggiani's know-how led to the creation of a system to remove dust and lint from the fabric to be printed. The new inverter allows the reduction of torque and modulation of the suction required.

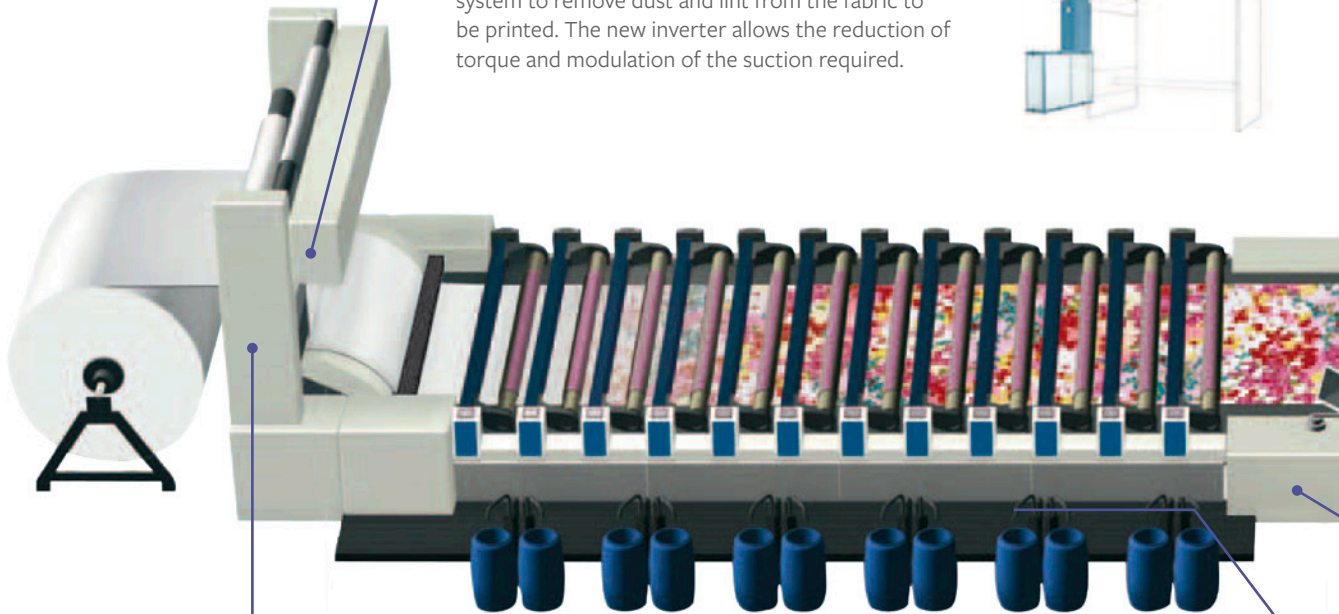

### THE NEW PNEUMATIC GLUE APPLICATION

Allows for perfect and continuous adjustment of the thickness of the glue on the fabric, reducing maintenance.

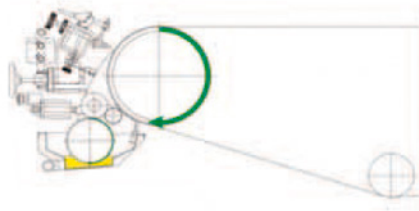

## RAPID PUMP WASHING (OPTIONAL)

This system was introduced on EFI Reggiani machines to dramatically reduce the waste of time and water, allowing the rapid washing of the color-feeding circuit (ducts, suction, delivery, color pump) by means of established sequences of pressurised water ejections. The standard time execution is 30 seconds; the maximum water consumption is 30 liters/color.

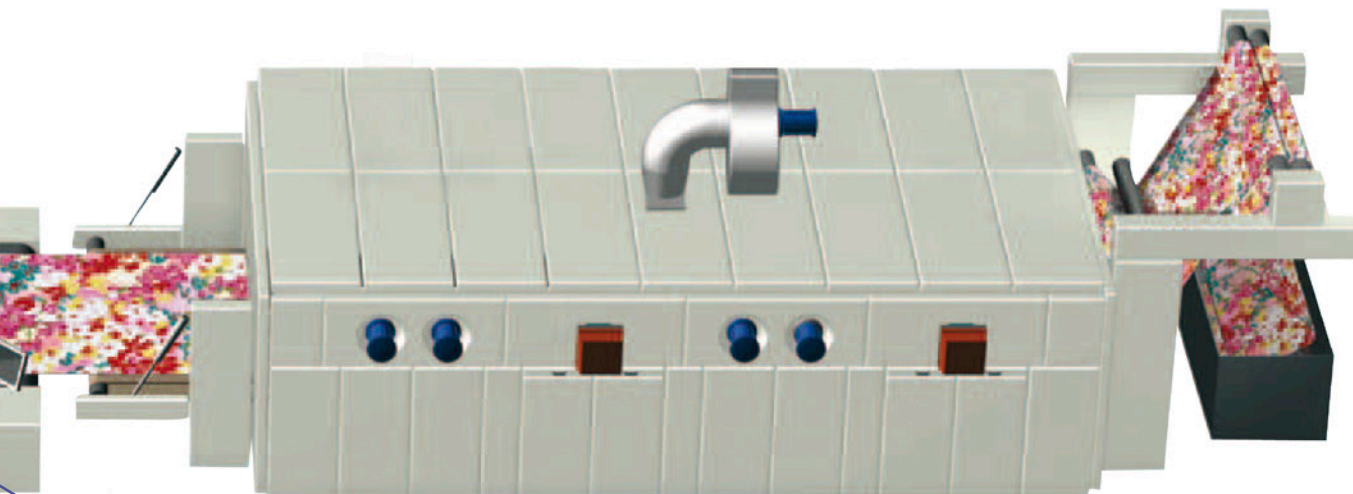

## THE NEW BLANKET WASHING SYSTEM

Considerably reduces water consumption. Two brushes, one for each tank, work with variable speed to optimise blanket cleaning. Four rubber squeegees (the last one adjustable as well) clean and dry the blanket perfectly. The two brushes are equipped with inverters that allow the reduction of torque and the adjustment of the brushes' rotation speeds according to the printing speed.

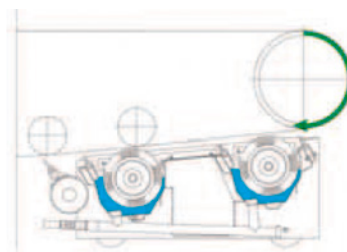

## PUMPS

Pneumatic stainless steel pumps with different deliveries. The high quality components allow the use of color pastes with different viscosities, always assuring perfect printing evenness.



## Closed-bearing print heads

- High precision and accuracy
- Self-aligning screen holders
- Evenness in screen tension
- Perfect driving of the screen
- No risk of damaging the screens, no mechanical wearing
- Totally sealed and lubricated print heads (no maintenance required)
- Easy screen installation (with one operator only)
- Optimum control/access to the printing, even with big repeats, thanks to the large distance between the print heads

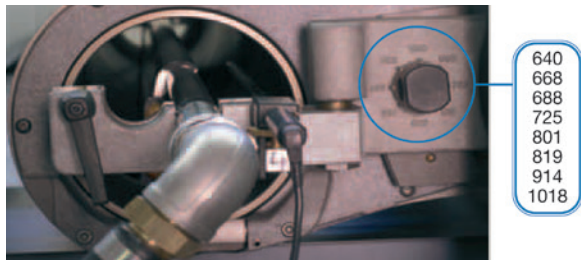

## Uniflux linear magnetic system

- Perfect evenness and uniformity, even with wide width fabrics
- No center-right, center-left effect
- High flexibility
- Digital printing pressure stepless adjustment, from ultra-low to very high pressure
- High efficiency and very low energy consumption
- No pole-to-pole overpressure (typical in multi-beam magnet systems)

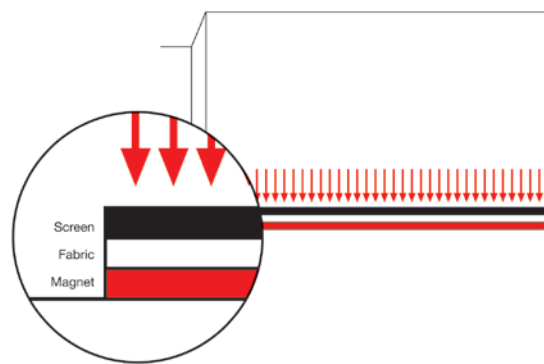

## Multi-repeat print heads

Totally pneumatic and electronically controlled between 25 in/640 mm and 40 in/1018 mm, and no tools are needed to change the repeat. The operator sets the repeat value on the main touch screen, and all the print heads raise up so the screens can be easily installed on the machine without any extra mechanical parts to save time.

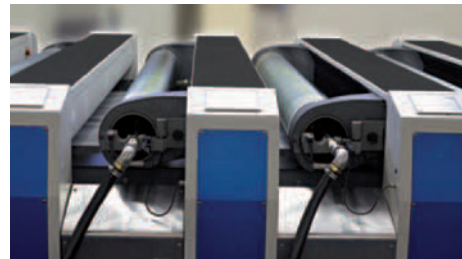

## Individual screen drive

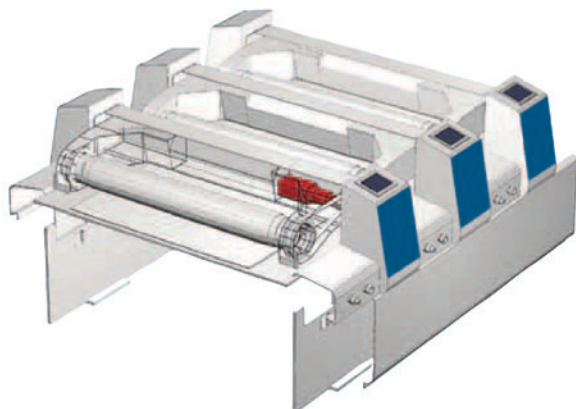

*With one brushless servomotor*

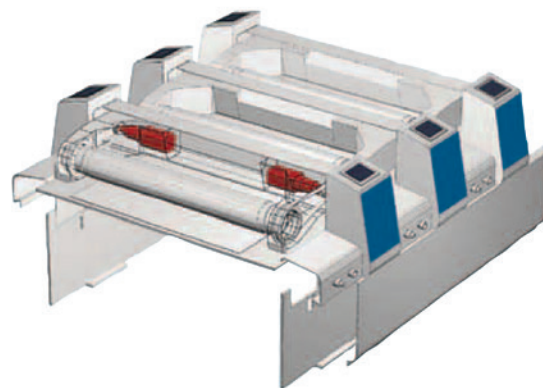

*With two brushless servomotors*

## Easy and friendly machine operations, high efficiency and low consumption

All the electronic components are the most updated and highest performing available on the market: the standard of Siemens (PLC, motion controls, inverters, control panels, and touch screens).

The interfaces are simple to understand and easy to use:

- One touch screen at the front of the machine
- One touch screen on each printing unit (optionally available on both sides)
- One main control board with a 15" TFT touch screen
- One touch screen at the exit of the dryer

The printing and design parameters can be easily adjusted, saved, and automatically reproduced. High reliability and very low energy consumption are the results of EFI's continuous efforts and investments in R & D.

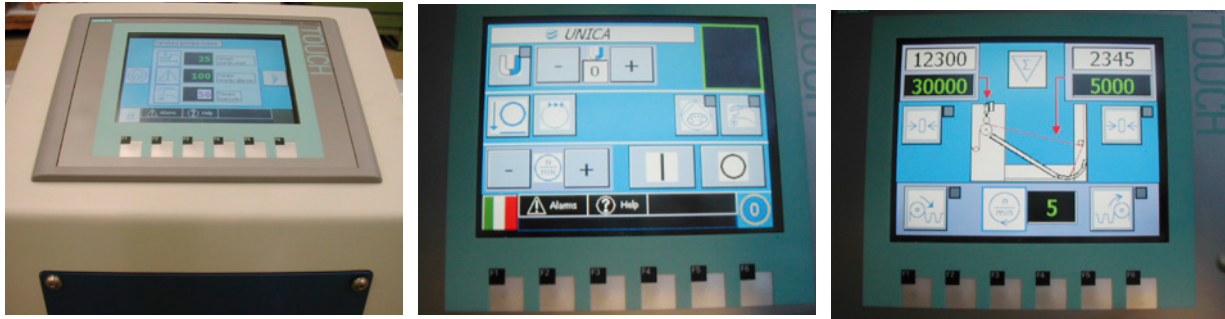

Energy consumption is becoming more and more important in an industrial budget.

EFI Reggiani, which has always been concerned about environmental issues, has equipped its UNICA rotary printing machines with inverters on the dust and lint removal device, on the blanket washing, on the dryer fans, and on the dryer exhaust to guarantee a 25% savings on energy consumption.

## Blade squeegee 180 cm, repeat 640

Squeegee blade isoform print height 1800, repeat 640. Each situation requires a diverse setup; with available adjustments of the printing squeegee system/color/cylinder the squeegee isoform can be used for any type of printing on any article. The operations of introduction/extraction is facilitated by the swivel releasing completely in the introduction section.

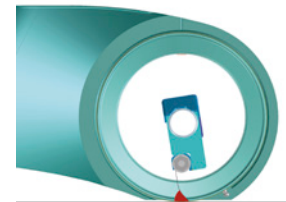

## Washing-on-line system (optional)

The washing-on-line (WOL) system patented by EFI Reggiani (patent N.1.271.128) is more and more appreciated by customers worldwide.

With no operator required, in 10-12 minutes, it is possible to wash and dry all the screens, pumps, color pipes, and the blanket on the machine.

The length and amount of washing and drying cycles can be determined by the operator (and then saved and automatically reproduced).

After the washing/drying cycles, the machine is ready to re-start printing without any extra time to register the screens.

Conceived mainly for the colorways, the WOL washes so fast and well that it is typically used for printing new designs, too.

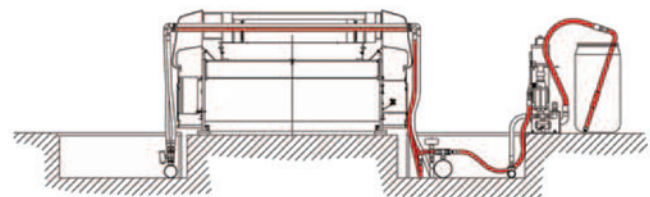

*During printing*

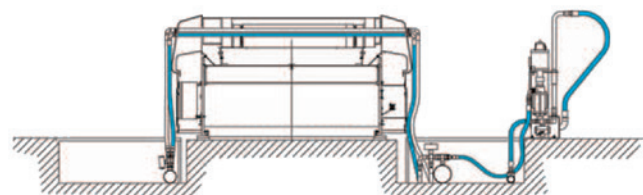

*During washing*

## TECHNICAL DATA

<b>Models</b>	71, 94, 126 in (180, 240, 320 cm)
<b>Number of colors</b>	up to 24
<b>Speed</b>	up to 295 ft/minute (90 m/minute)
<b>Print heads</b>	closed bearing, self-aligning, lubricated
<b>Multi-repeat print heads</b>	from 25 to 40 in (640 to 1018 mm), stepless adjustment, electronically controlled
<b>Screen drive</b>	with one or two brushless motors
<b>Printing width</b>	stepless adjustment
<b>Squeegee system</b>	with Uniflux linear magnetic system
<b>Operating and color side</b>	right or left
<b>Gluing system</b>	water soluble glue as well as thermoplast
<b>Blanket washing system</b>	two variable speed brushes, four rubber squeegees (the last one adjustable)
<b>Interfaces</b>	touch screens on each printing unit, touch screens at the entry/exit of the machine, one control board with a 15" TFT touch screen; all with colors
<b>Electrical cabinet</b>	conditioned
<b>Tele assistance</b>	built-in modem for troubleshooting and telediagnosis

EFI reserves the right to modify, at any moment and without prior notice, the data and technical specifications published herein.

## Let's be brilliant. Together.

We understand you want breakthrough technologies to lead you through your digital journey. That's why we're passionate about driving your business growth with a scalable portfolio of products, solutions, services, support, and world-class partnerships for the manufacturing of signage, packaging, textiles, ceramic tiles, and building materials with a wide range of printers and inks. Our unwavering commitment is to increase your profits, cut costs, improve productivity, and optimize efficiency — job after job, year after year. We're obsessed with your success. And we definitely believe we have the right people, technology and experience to help your business achieve its goals. Visit [www.efi.com/reggiani](http://www.efi.com/reggiani) or send an email to [info@efi.com](mailto:info@efi.com) for more information.



Nothing herein should be construed as a warranty in addition to the express warranty statement provided with EFI products and services.

BDR, Cretachrom, Cretaprint, the Cretaprint logo, Cretaprinter, Cretaroller, Divisional Graphics, Distancing Graphics, EFI, the EFI logo, Electronics For Imaging, FabriVU, Fast-4, Inèdit, Inkintensity, Inkware, neoCatalog, neoStampa, neoTextil, PressVu, ProGraphics, Rialco, Riaplas, SDC, SafeGuard Graphics, UltraDrop, UltraPress, UltraTex, UltraVu, UV Series 50, VUTEK, and the VUTEK logo are trademarks or registered trademarks of Electronics For Imaging, Inc. and/or its wholly owned subsidiaries in the U.S. and/or certain other countries.

All other terms and product names may be trademarks or registered trademarks of their respective owners and are hereby acknowledged.